

Silicon PNP Power Transistors

2SA1860

DESCRIPTION

- With TO-3PML package
- Complement to type 2SC4886

APPLICATIONS

- Audio and general purpose

PINNING

PIN	DESCRIPTION
1	Emitter
2	Collector
3	Base

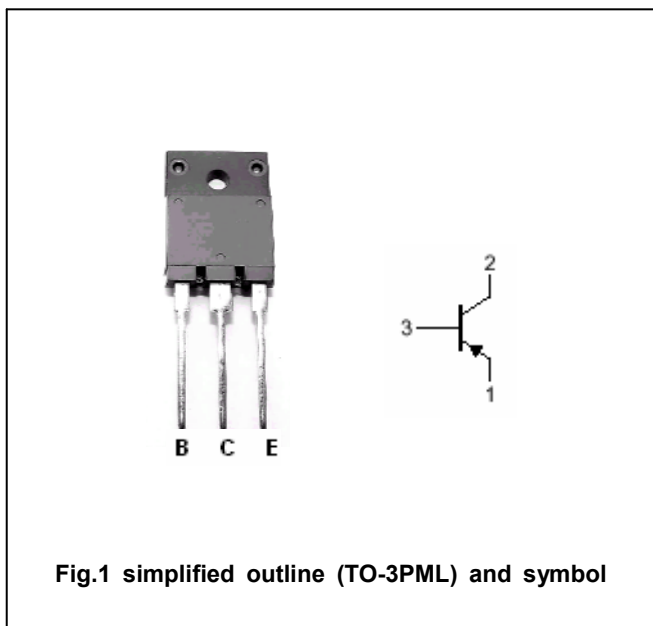

Fig.1 simplified outline (TO-3PML) and symbol

Absolute maximum ratings(Tc=25°C)

SYMBOL	PARAMETER	CONDITIONS	VALUE	UNIT
V_{CBO}	Collector-base voltage	Open emitter	-150	V
V_{CEO}	Collector-emitter voltage	Open base	-150	V
V_{EBO}	Emitter-base voltage	Open collector	-5	V
I_C	Collector current		-14	A
I_B	Base current		-3	A
P_C	Collector power dissipation	$T_c=25^\circ C$	80	W
T_j	Junction temperature		150	°C
T_{stg}	Storage temperature		-55~150	°C

Silicon PNP Power Transistors

2SA1860

CHARACTERISTICS

T_j=25 °C unless otherwise specified

SYMBOL	PARAMETER	CONDITIONS	MIN	TYP.	MAX	UNIT
V _{(BR)CEO}	Collector-emitter breakdown voltage	I _C =-25mA; I _B =0	-150			V
V _{CEsat}	Collector-emitter saturation voltage	I _C =-5 A; I _B =-0.5 A			-2.0	V
I _{CBO}	Collector cut-off current	V _{CB} =-150V; I _E =0			-100	μA
I _{EBO}	Emitter cut-off current	V _{EB} =-5V; I _C =0			-100	μA
h _{FE}	DC current gain	I _C =-5A ; V _{CE} =-4V	50		180	
f _T	Transition frequency	I _C =-2A ; V _{CE} =-12V		50		MHz
C _{OB}	Output capacitance	I _E =0; V _{CB} =-10V; f=1MHz		400		pF

Switching times

t _{on}	Turn-on time	I _C =-5A; R _L =12Ω I _{B1} =-I _{B2} =-0.5A V _{CC} =-60V		0.25		μs
t _s	Storage time			0.85		μs
t _f	Fall time			0.20		μs

◆ h_{FE} classifications

O	P	Y
50-100	70-140	90-180

Silicon PNP Power Transistors

2SA1860

PACKAGE OUTLINE

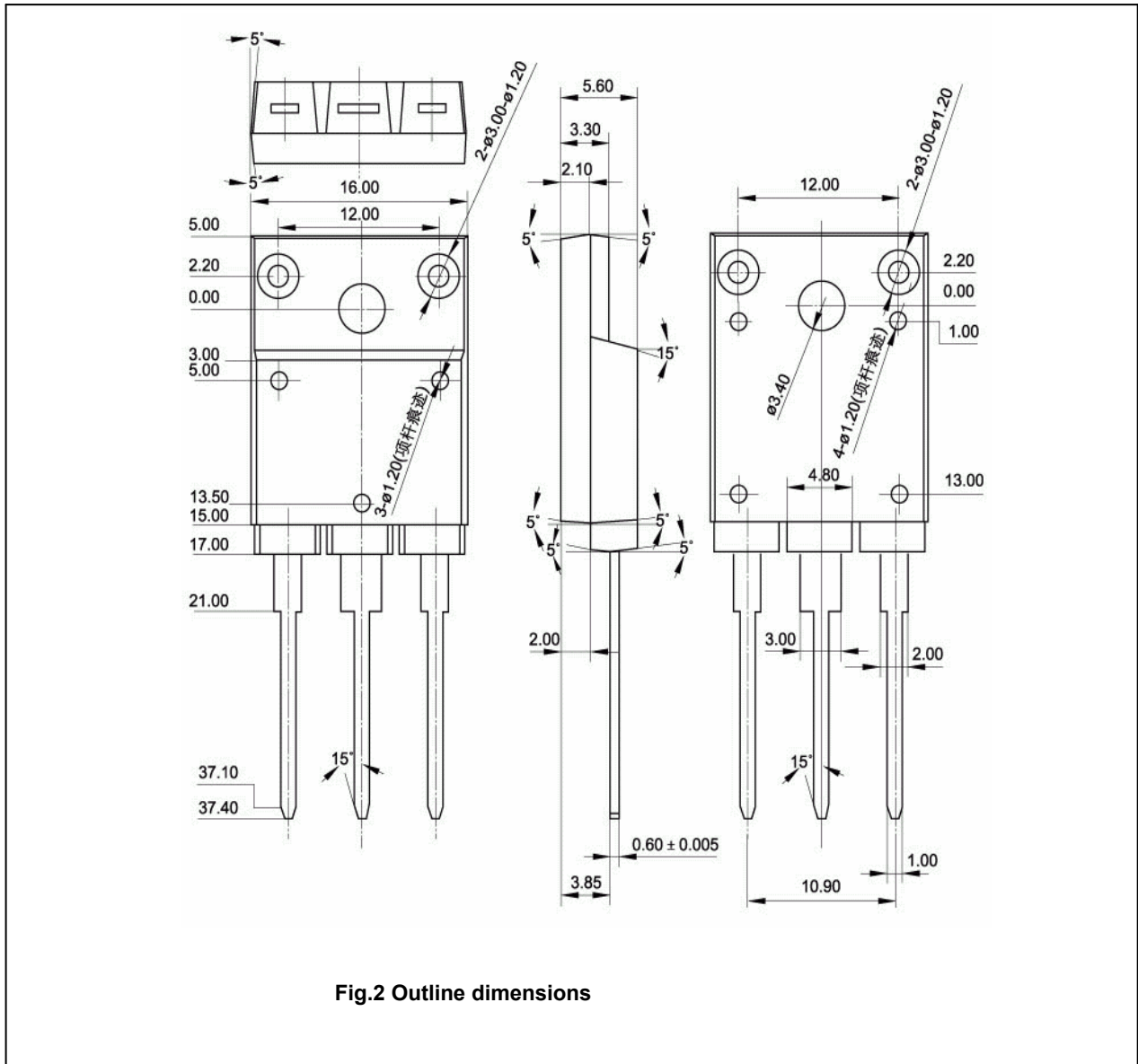

Fig.2 Outline dimensions

Silicon PNP Power Transistors

2SA1860

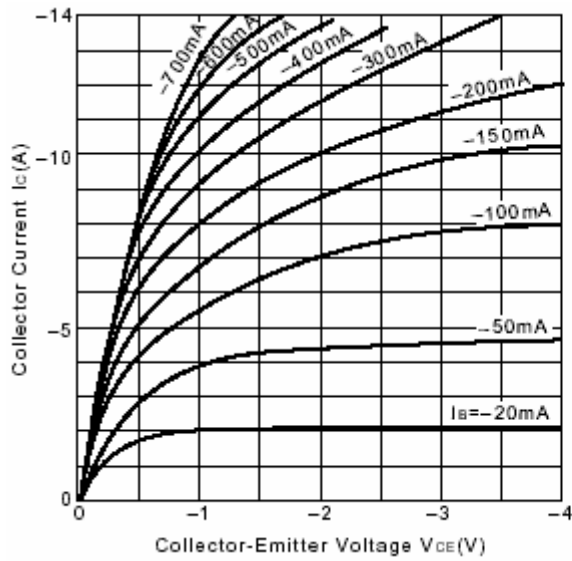

Fig.3 Static Characteristic

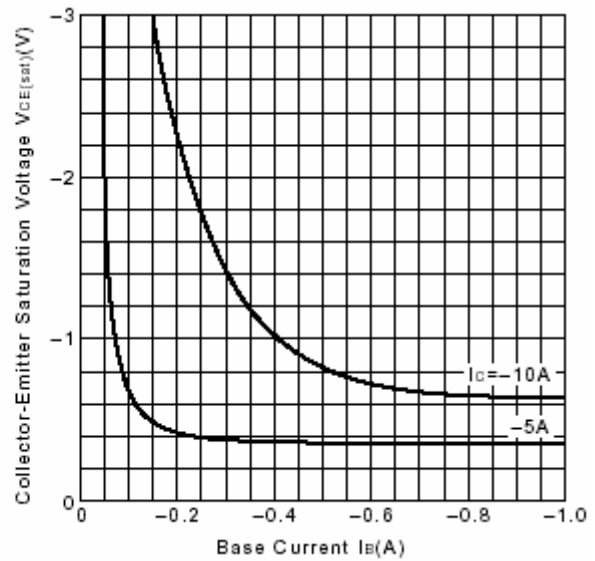

Fig.4 $V_{CE(sat)}-I_B$ Characteristics

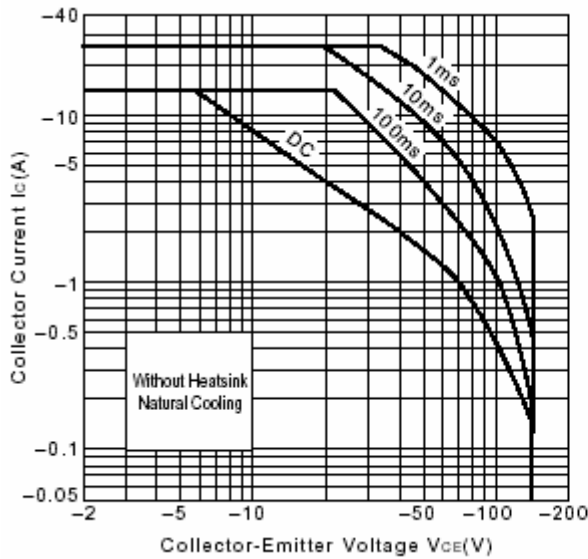

Fig.5 Safe Operating Area

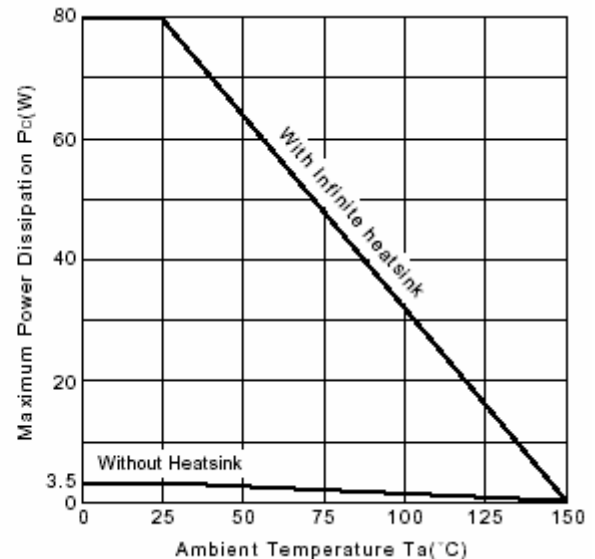

Fig.6 P_c-T_a Derating

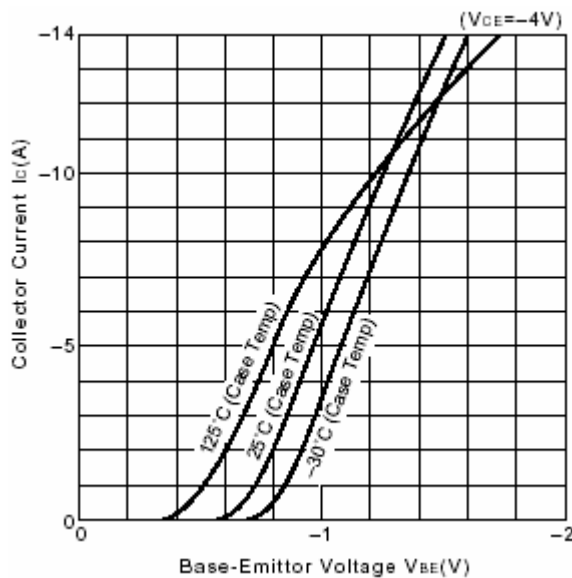

Fig.7 I_C-V_{BE}

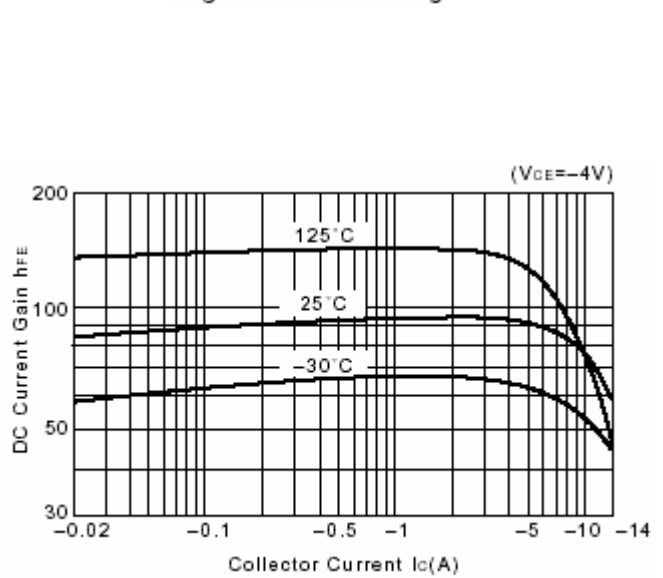

Fig.8 DC current Gain